

:

:

:

:

:

:

:

} #

2.1

BB

2.3

2.4

2.5

3.1

3.1.1



3.1-1

3.1.2

3.1-1

			m	

			m	

3.1.3

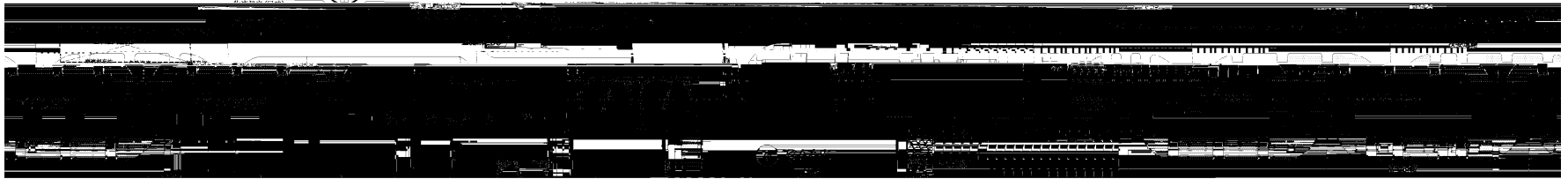

3.1-2



3.2

3.2.1



E (BPE E

~

∇

!!

WA



■

3.2-5

/

/

0)89.192+

B

			1			1		



/ /

/ /









/ /

/ /



/ /

/ /

20# **60**

BA
22#

3.3

3.5

1

2

3

4

3.5-1

t

kg

t

t

t

kg

t

t

5

6

7

8

9

10

11

12

13

14

15

16

17

0 0 8

-174.18

-5475

+15522.76

-27593.23

-4250.98

3 2 2 3 7

3.5-4

				-530.47	
				-8928	
				+52669.2	
				-79077.1	
				-6930	
				+52669.2	
				-95465.57	

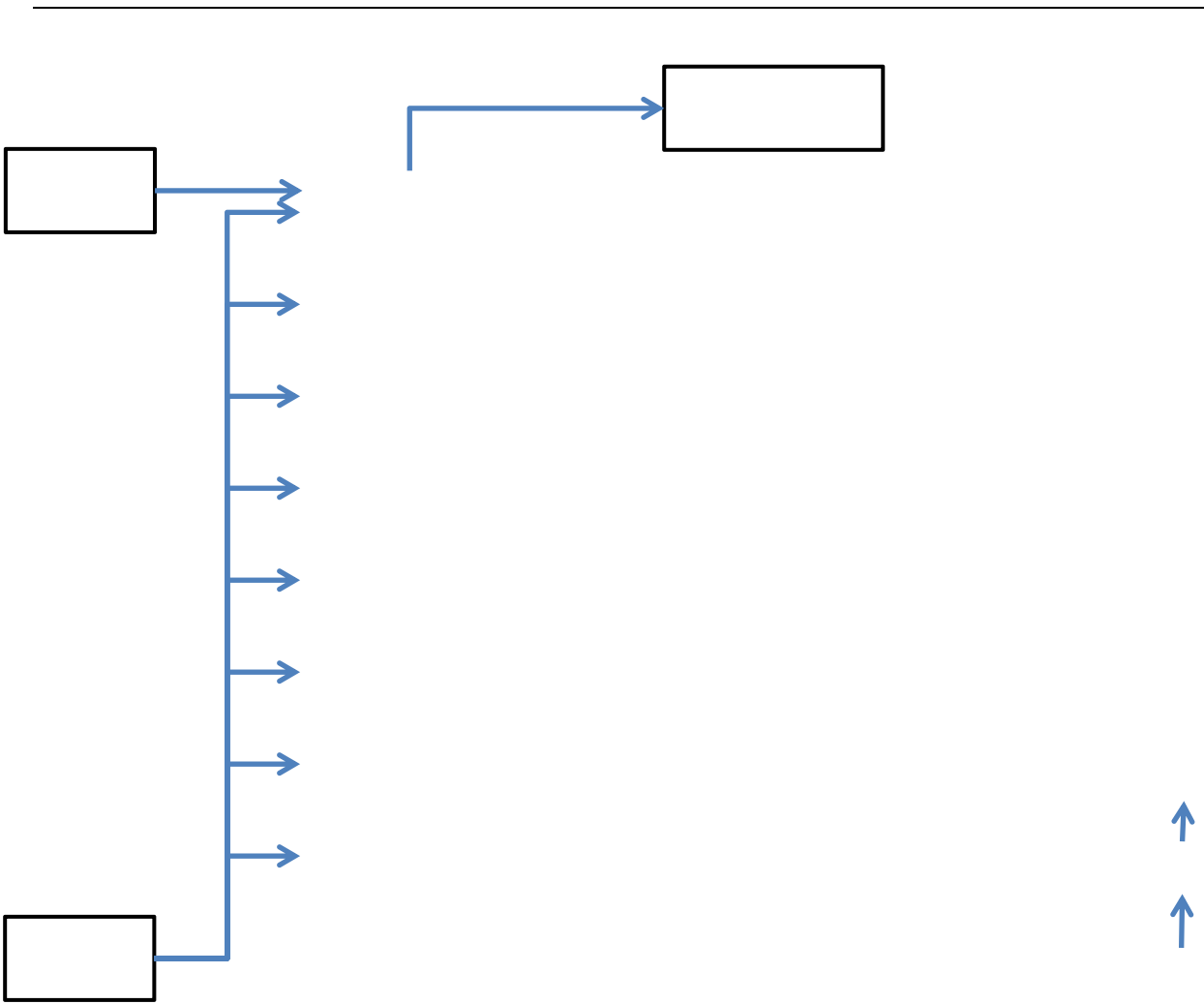

3.6

3.6-1

	2018 6				

	2018 6				
		2	1		
			2		
		1	1		

	2018 6				
		2	2		
		3	3		
		4	4		
		5	5		
		6	6		
		7			

	2018 6				
			7		

3.6.2

3.6.3

4.1

4.1.1

4.1.2

4.1-1

4.1.4

4.1-2

B049				
X8				
B044				

BA				

4.1.5

1

SE
E
A

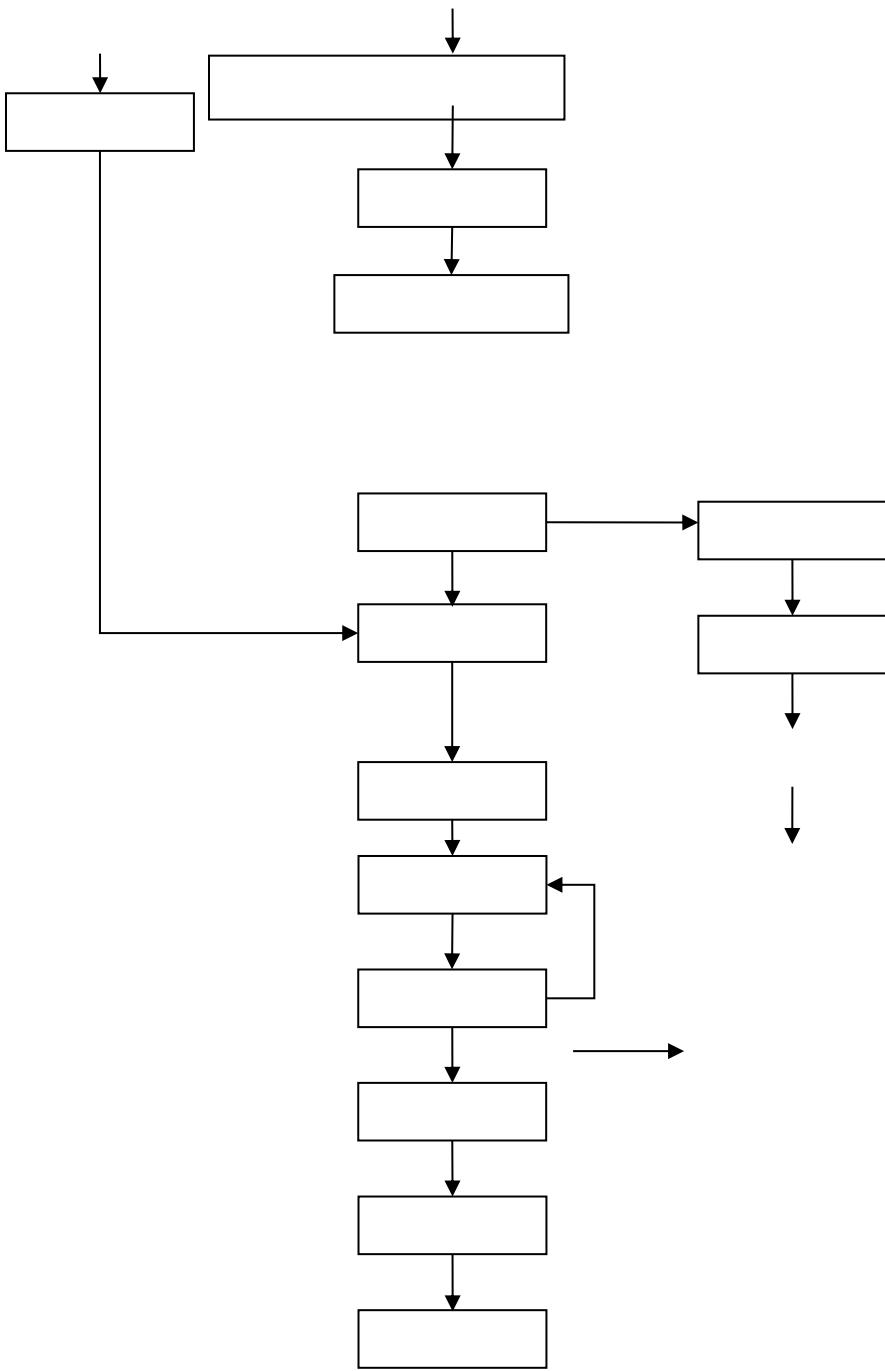

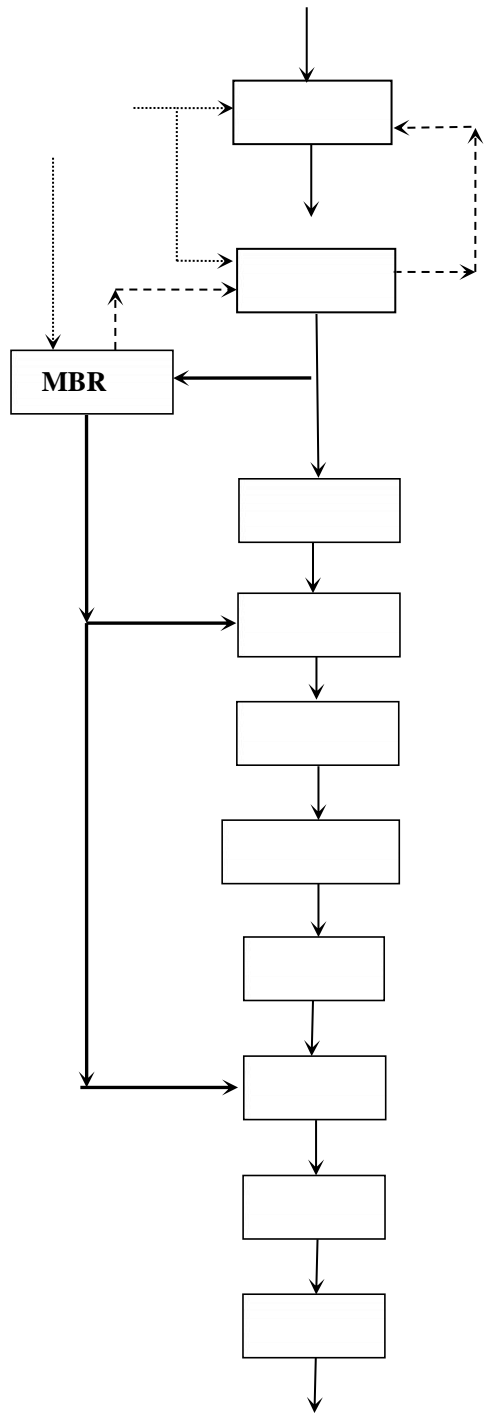
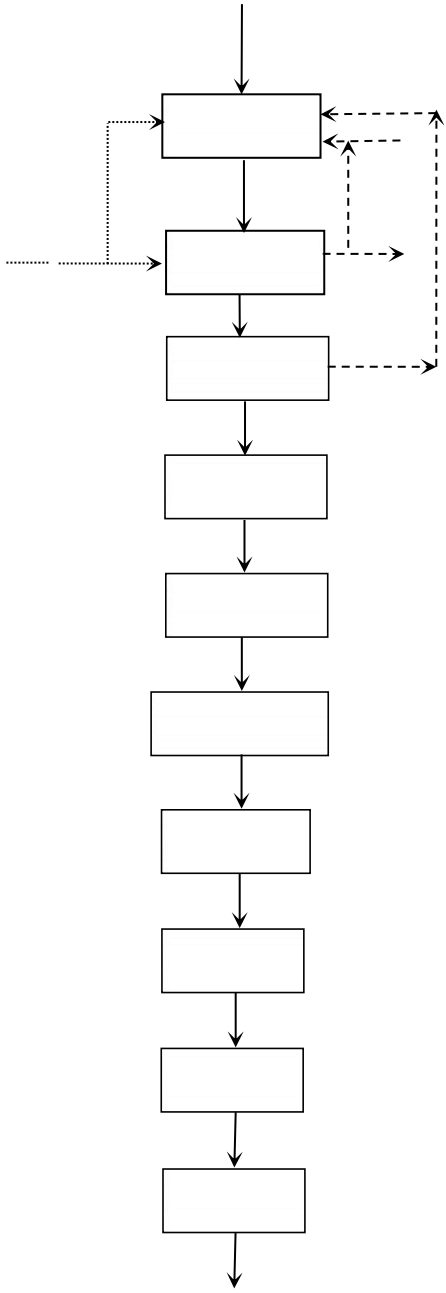

4.1-2

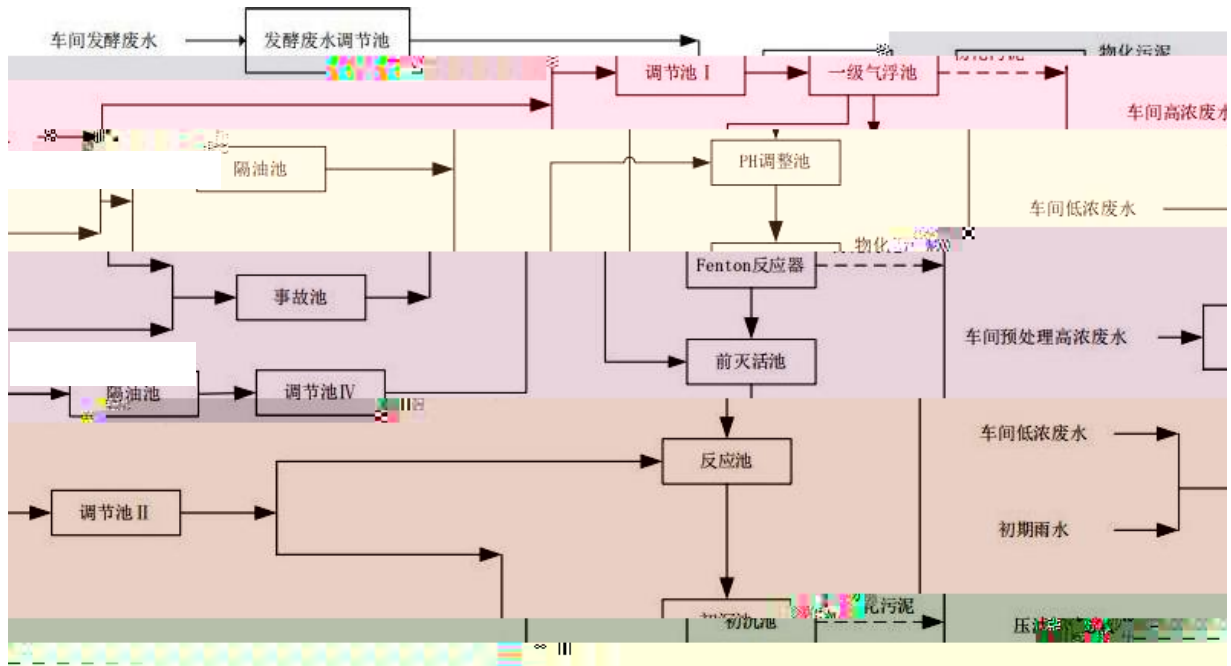

4.1-3



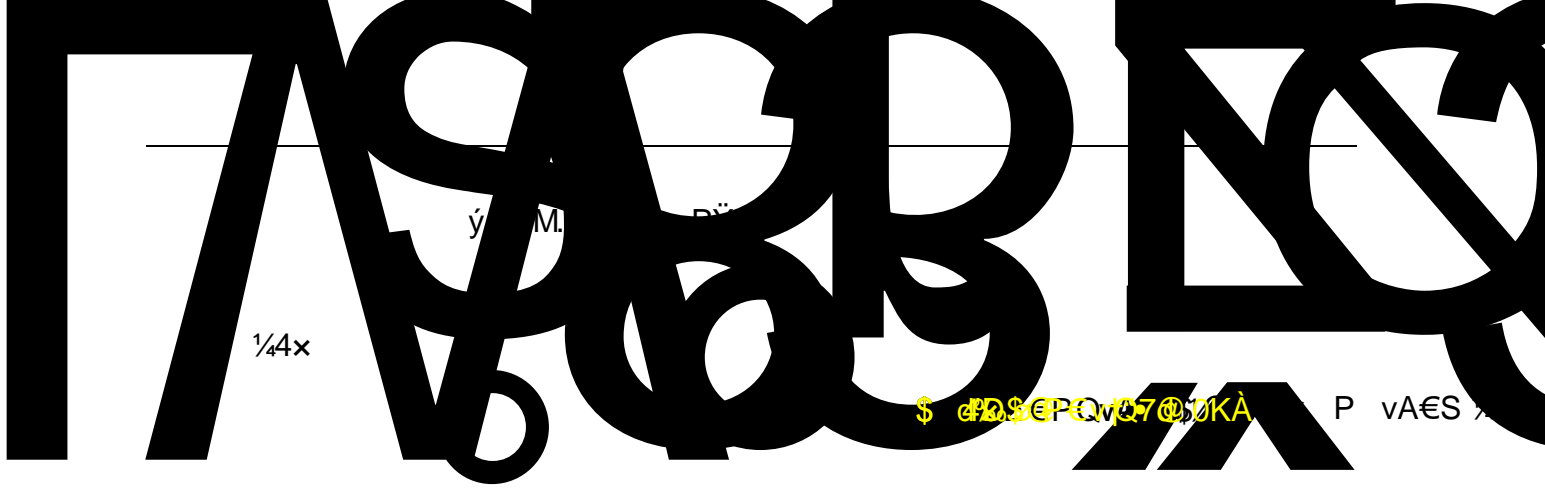

1/4x

ý M. D

\$ @P\$@PQV@7@JKÁ

P vA€S

\$ H@P\$@PQV@7@JKÁ

4.2

4.2.1

4.2.2

4.2-1

4.2.3

4.2.4

4.2-2

4.2-3

(

~~x — " b29€H'•5 † n(~ 8~~

	+	+
	+	1# +
		2# +
	+	"D + + Â'D



4.2.6

4.3

4.3-1

4.4

4.4.1

4.4.2

4.4.3

4.4-1

4.4.4

4.4-2

HW06 900-401-06 HW06 900-402-06 HW06 900-404-06

2021

15

HW02 271-002-02

GB18597-2023
GB18599-2020

4.4-3

HW06 900-401-06 HW06 900-402-06 HW06 900-404-06

2021

15

HW02 271-002-02

GB18597-2023

GB18599-2020

4.5

4.6

4.6.1

4.6.1.1

1

4.7“ ”

4.7.1 “ ”

4.7.2

4.7-1

4.7.3“ ”

4.7-2 “ ”

5.1

5.1.1

5.1.2

5.1.3

5.1.5

5.1.6

1. “ ”

3.

4.

[2016]150 “ ”



6.



DE & NC
H
E

5.2.2

2018

5.3

5.4

6.1

6.1.1

6.1-1

12	1	3	31		

6.1-3

	mg/m³			
	RTO			

1,2,3-

1,2,4-

1,3,5-

6.1-4

VOCs

6.1-5

TVOC

6.1-6

	mg/m ³			
	RTO			

1,2,3-

1,2,4-

1,3,5-

6.1-7

DB33/310005-2021

6.1-8

GB14554-93

		m	kg/h	mg/m³

6.1.3

6.1-9

GB12348-2008

	dB	dB

6.1.4

6.1.5

6.1-10

	t/a	t/a	t/a	kg/a	t/a	t/a	VOCs t/a
	22069	0.662	0.033	0.14	0.72	0.04	2.46
	/	13.131	0.656	1.16	21.462	1.05	26.83

6.1-11

	t/a	t/a
	1.5	1.5
	27.978	1.575

6.1-12

					“	”	t/a	T5
	t/a	t/a T1	t/a	t/a T2				

T1

3.2-1 3.2-3

T2

1

7661t/a

2

4525t/a

3

1196.2t/a

4

1794.2t/a

5

1350t/a

6

225t/a

7

225t/a

8

225t/a
9

867t/a

18068.4t/a

0.542t/a

0.027t/a

T3 “ ”

9.3.2-1

T4 = T1 + T2 - T3

T5 433682.4t/a

5.204t/a

3.3.1-5

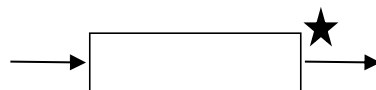
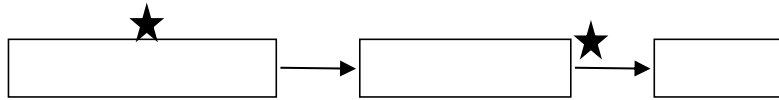
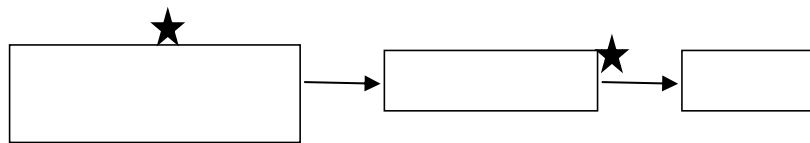
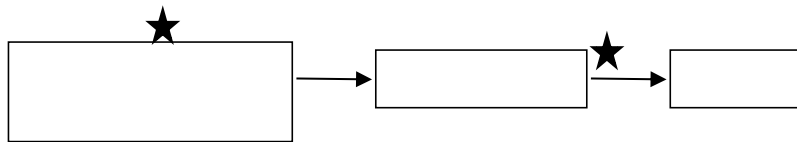

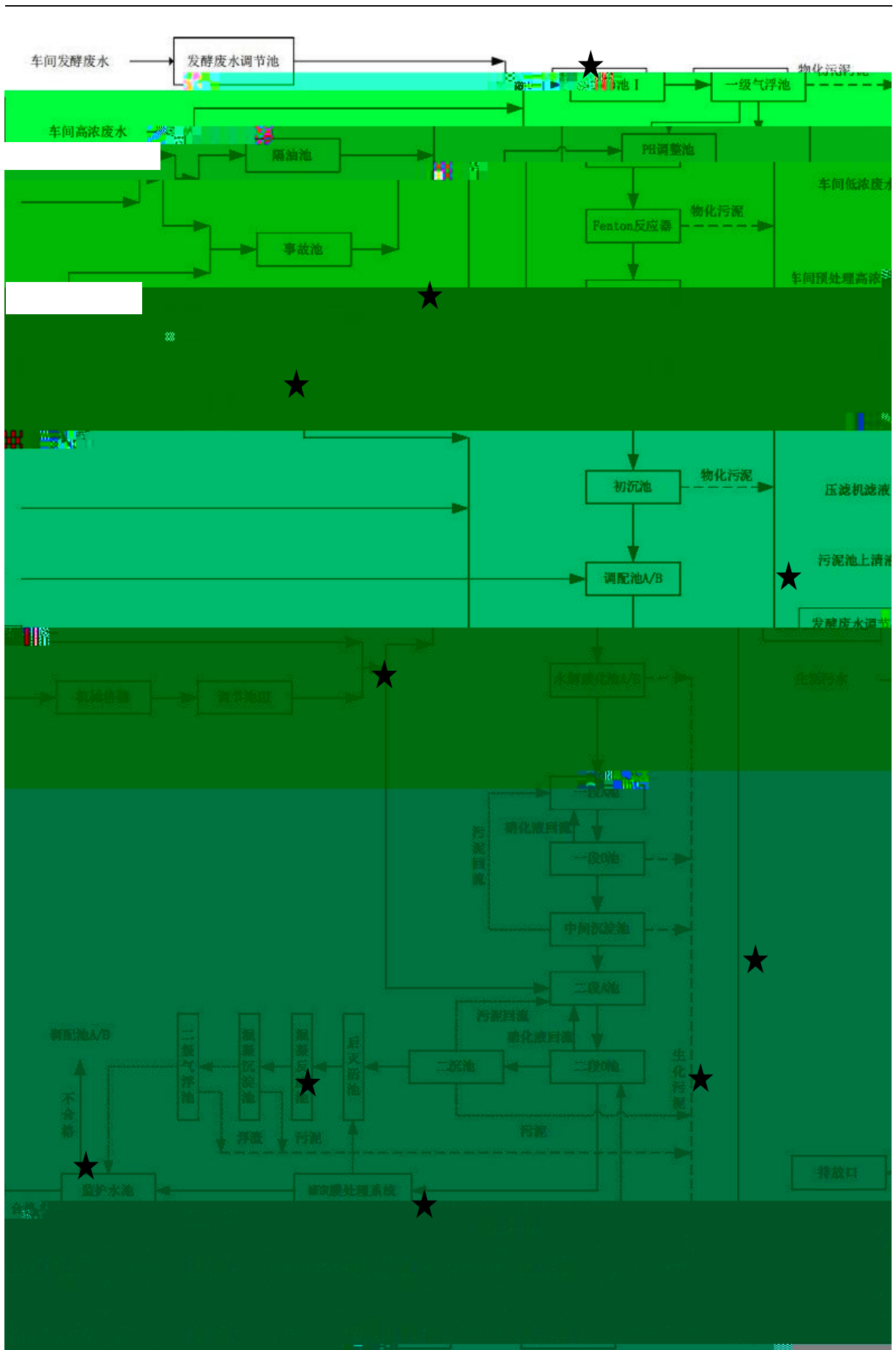

7.1-1

7.2



7.2-1

	RTO			
	RTO			
		+		
		+		

7.2-1

	1# +			
	2# +			
		+		
	+			
		+		
	+			



	7.2-2	VOCs		
VOCs			“	”
	t/a	t/a	t/a	t/a

VOCs	t/a	t/a	“ ”	t/a	t/a

DB33/31005-2021

90% VOCs

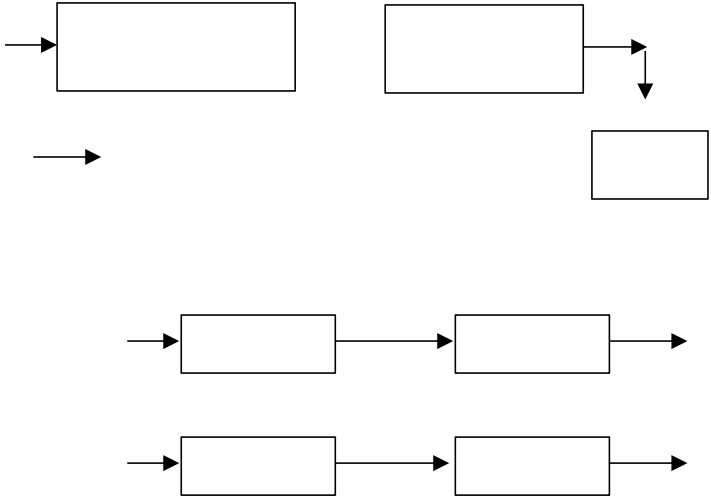



7.2-3

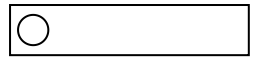
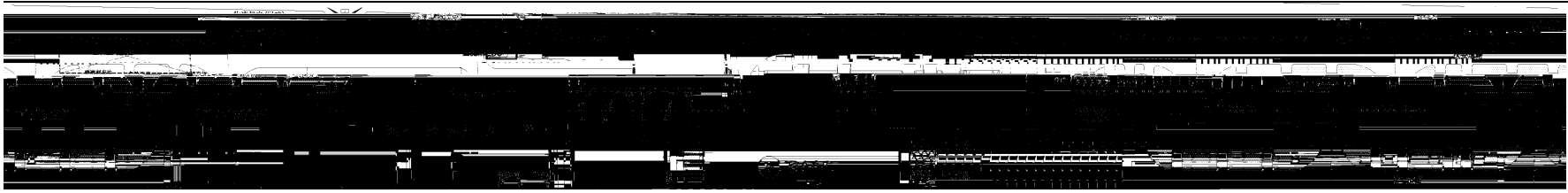



8.1-2

/

/

x 08#

0000-

✓

„D. (0000) 64X LINC. ULYBI 0

6 190

8.1-4

8.2-1

“ND”

8.2-5

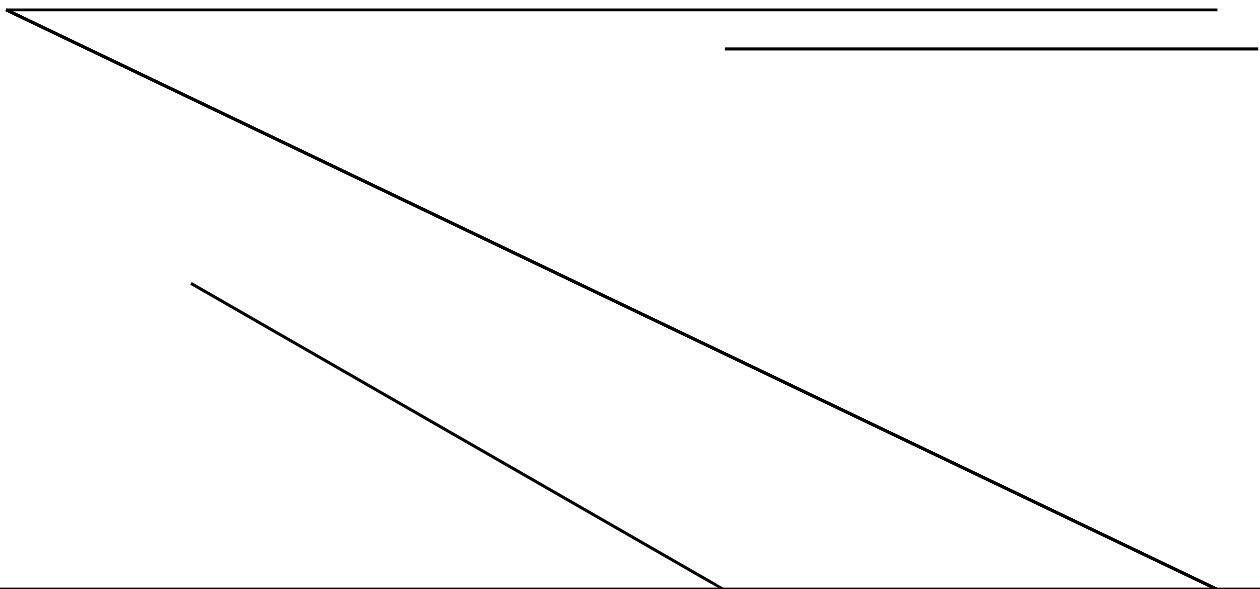

8.2-6

9.1

	t	(kg/d)	2023 8 24	2023 8 25	2023 8 31	2023 9 1	2024 1 26	2024 2 2	2024 2 3	
			(kg/d)	(kg/d)	(kg/d)	(kg/d)	(kg/d)	(kg/d)	(kg/d)	

1

2 B049

21kg 4 1

B044

17kg 3 1

3

75%

9.1-2

9.2

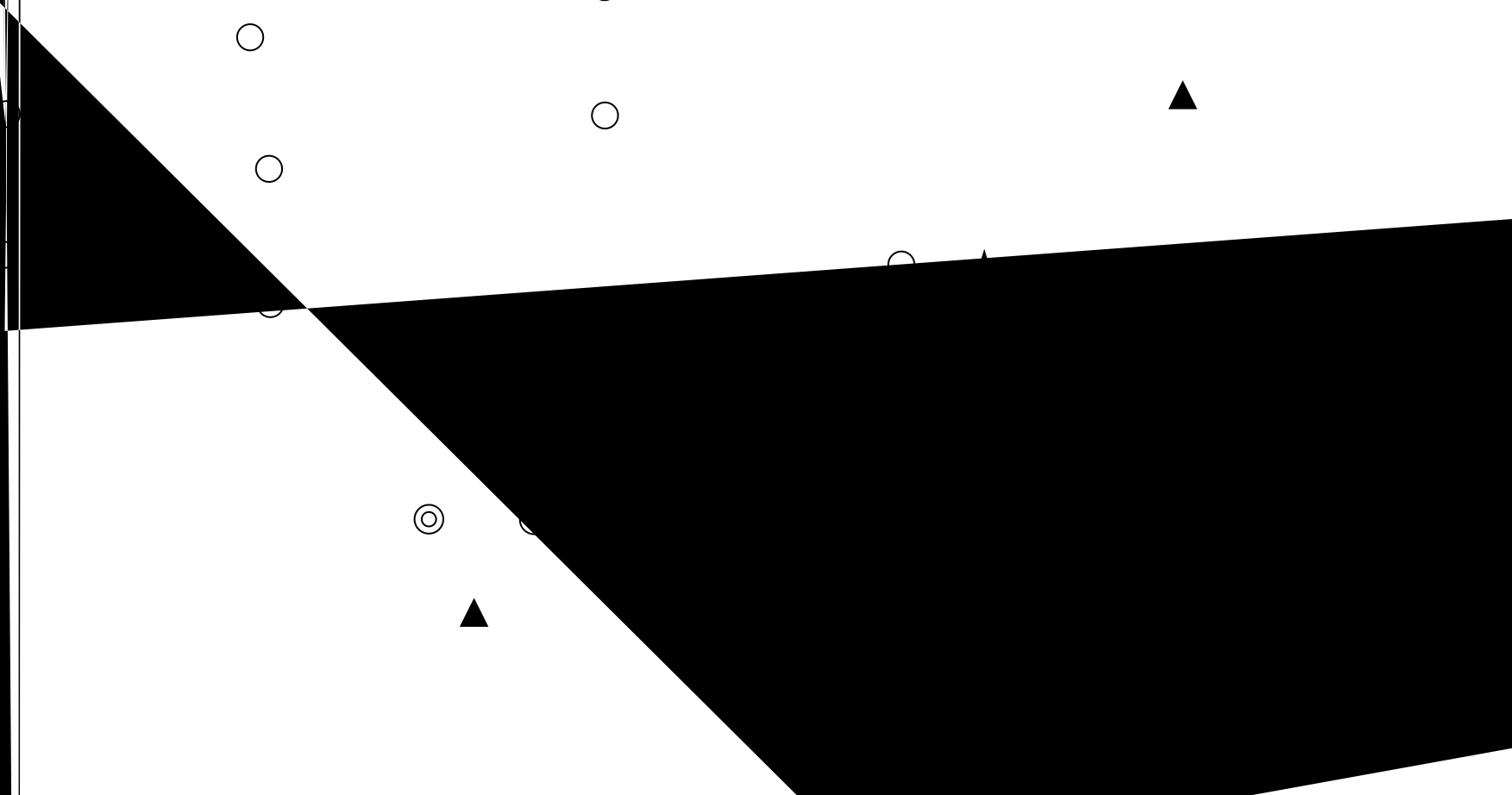
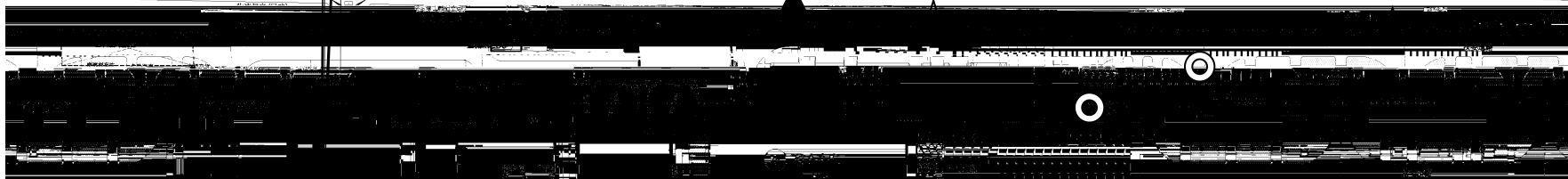

9.3

9.3-1

9.3-1

	Y_i kg	Q m ³	Q_i t/t	

9.4.1.2

9.4-2

		pH ()	(mg/L)	(mg/L)	(mg/L)	(mg/L)	(mg/L)	(mg/L)	(mg/L)	(mg/L)	(mg/L)	(mg/L)	(mg/L)	(mg/L)	(μg/L)	(μg/L)	(μg/L)
		/	/	2.40×10 ⁵	2.42×10 ⁵	>6000	1.17×10 ⁵	4.86×10 ³	1.79×10 ⁴	0.18	14	1.50×10 ⁴	0.32	1.28	5.2	5.40×10 ⁴	4.24×10 ⁴
		/	/	2.38×10 ⁵	2.46×10 ⁵	>6000	1.13×10 ⁵	4.70×10 ³	1.81×10 ⁴	0.20	16	1.32×10 ⁴	0.67	0.62	1.8	8.40×10 ⁴	6.36×10 ⁴
		/	/	1.08×10 ⁴	1.15×10 ³	109	6.24×10 ³	776	1.09×10 ³	0.08	15	0.36	0.13	0.22	<1.4	<6.13	311
		/	/	1.16×10 ⁴	1.18×10 ³	87.4	6.35×10 ³	919	1.05×10 ³	0.11	14	0.27	0.41	0.26	<1.4	234	588
day1	%	/	/	95.5%	99.5%	>98.2%	94.7%	84.0%	93.9%	55.6%	/	99.9%	59.4%	82.8%	86.5%	99.9%	99.3%
day2	%	/	/	95.1%	99.5%	>98.5%	94.4%	80.4%	94.2%	45.0%	/	99.9%	38.8%	58.1%	61.1%	99.7%	99.1%

		9.4-3		COD										
pH ()		(mg/L)	(mg/L)	(mg/L)	(mg/L)	(mg/L)	(mg/L)	(mg/L)	(mg/L)	(mg/L)	(µg/L)	(µg/L)	(µg/L)	
		/	/	3.78×10 ⁵	>6000	405	94.5	35	206	33.8	0.48	1.24×10 ³	9.96×10 ⁶	5.56×10 ⁶
		/	/	2.40×10 ⁵	>6000	363	92.1	30	192	29.4	0.26	1.39×10 ³	5.88×10 ⁶	4.79×10 ⁶
		/	/	3.87×10 ⁴	>6000	336	89.6	21	9.42	2.08	0.10	1.2	8.78×10 ³	6.44×10 ³
		/	/	2.92×10 ⁴	>6000	276	88.0	12	11.0	3.46	0.27	7.5	2.51×10 ⁴	2.10×10 ⁴
%	day1	/	/	89.8%	/	17.0%	/	40.0%	95.4%	93.8%	/	99.9%	99.9%	99.9%
%	day2	/	/	87.8%	/	24.0%	/	60.0%	94.3%	88.2%	/	99.5%	99.6%	99.6%

9.4.4

			pH ()		(mg/L)	(mg/L)	(mg/L)	(mg/L)	
				/	/	0.174	1.98	0.033	555
				/	/	0.156	2.44	<0.004	498
				/	/	0.030	0.172	<0.004	236
				/	/	0.034	0.274	<0.004	239
			/	/	0.5	1.5	1.0	/	
day1 %			/	/	82.8%	91.3%	/	57.5%	
day2 %			/	/	78.2%	88.8%	/	52.0%	

9.4-5

pH ()	()	(mg/L)	(mg/L)	(mg/L)	(mg/L)	(mg/L)	(mg/L)	(mg/L)	(mg/L)	(mg/L)	(mg/L)	(mg/L)	(mg/L)	(μg/L)	(μg/L)	(μg/L)	(mg/L)	(mg/L)	(mg/L)	(mg/L)
/	/	4.08×10 ⁴	>6000	1.07×10 ³	163	190	13.8	30	93.3	6	39.9	0.30	6.76×10 ⁴	2.57×10 ⁵	1.97×10 ⁵	/	/	/	/	
/	/	3.88×10 ⁴	>6000	992	134	160	8.87	27	70.1	5	33.8	0.31	7.66×10 ⁴	5.04×10 ⁵	4.00×10 ⁵	/	/	/	/	
/	/	1.82×10 ³	598	906	10.3	46.2	0.47	22	8.36	6	5.10	0.03	226	2.44×10 ³	2.21×10 ³	/	/	/	/	

pH ()	()	(mg/L)	(mg/L)	(mg/L)	(mg/L)	(mg/L)	(mg/L)	(mg/L)	(mg/L)	(mg/L)	(mg/L)	(mg/L)	(μg/L)	(μg/L)	(μg/L)	(mg/L)	(mg/L)	(mg/L)	(mg/L)
/	/	7.08×10 ³	3.61×10 ³	2.65×10 ³	338	387	3.08	76	20.2	30	31.0	0.18	1.91×10 ⁴	2.20×10 ⁴	1.79×10 ⁴	6.65	0.038	0.004	/
/	/	7.97×10 ³	3.12×10 ³	2.41×10 ³	303	347	1.91	32	21.7	6	31.0	0.22	3.31×10 ⁴	4.12×10 ⁴	3.10×10 ⁴	5.33	0.027	0.007	/
/	/	3.53×10 ³	1.66×10 ³	2.12×10 ³	227	287	10.5	106	3.11	48	18.9	0.19	2.53×10 ³	2.67×10 ³	2.22×10 ³	11.6	0.031	0.019	/
/	/	4.21×10 ³	1.40×10 ³	2.17×10 ³	228	269	9.91	359	2.97	425	17.4	0.24	1.84×10 ³	1.07×10 ⁴	6.83×10 ³	11.2	0.038	0.010	/

		pH ()	()	(mg/L)	(mg/L)	(mg/L)	(mg/L)	(mg/L)	(mg/L)	(mg/L)	(mg/L)		(mg/L)	(mg/L)	(μg/L)	(μg/L)	(μg/L)	(mg/L)	(mg/L)	(mg/L)	(mg/L)
		/	/	216	25.1	1.64×10 ³	9.38	22.1	2.34	12	0.18	6	15.1	0.08	1.4	<6.13	214	0.24	0.024	<0.004	/
		/	/	223	42.5	2.16×10 ³	1.50	21.5	4.63	19	0.09	7	16.4	0.06	28.3	<6.13	396	0.07	0.011	<0.004	<0.004
		/	/	176	25.0	1.67×10 ³	8.68	20.8	2.00	16	0.11	6	13.4	0.04	<1.4	<6.13	347	0.16	0.018	<0.004	<0.004
		6~9	/	480	300	/	35	120	8	120	20	60	20	5.0	500	/	8000	100	/	/	/

9.4-5

			(mg/L)	
			46.8	
			40.2	
			180	

ZTE202401132

ZTE202401419

12

9.4-6

		(mg/L)	(mg/L)	(mg/L)
		1.0	1.0	1.0

9.4-10 "MBR"

	(mg/L)	(mg/L)	(mg/L)	(mg/L)	(mg/L)	(mg/L)	(mg/L)	(mg/L)	(mg/L)	(mg/L)	(μg/L)	(μg/L)	(μg/L)	(mg/L)	(mg/L)	(mg/L)
day1 %	77.3%	86.0%	/	79.0%	64.7%	42.3%	92.4%	14.0%	/	/	/	/	/	38.0%	/	/
day2 %	79.6%	2														

Y P 3C "#

9.4-12

	pH ()		(mg/L)	(mg/L)	(mg/L)	(mg/L)	(mg/L)	(mg/L)	(mg/L)	(mg/L)
	/	/	9	0.64	0.02	12	<0.01	<0.004	<0.004	
	/	/	16	0.67	0.04	11	<0.01	<0.004	<0.004	
	/	/	50	/	/	/	/	/	/	/

9.4.1.3

9.4-13

	mg/L	mg/L	t/a	t/a	t/a
		/		433682.4	
		30		13.011	
		1.5		0.65	
		12		5.204	
		0.1		1.16×10^{-3}	

IV

GB18918-2002

A

9.4.1.4

IAO

	pH	(mg/L)	(mg/L)	mg/L	mg/L
	6-9	480	35	120	8

9.4.1.5

COD

5.204t/a

$1.16 \times 10^{-3} \text{t/a}$

13.011t/a

0.65t/a

9.4.2

9.4.2.1

9.4-15



2#

1#

2#

/

P

9.4-16 RTO

RTO
3#

4#

+RTO+
3#

4#

30

9.4-16 RTO

**RTO
3#**

4#

**+RTO+
3#**

4#

30

mg/m³

/

/

/

/

9.4-16 RTO

RTO

3#

4#

4#

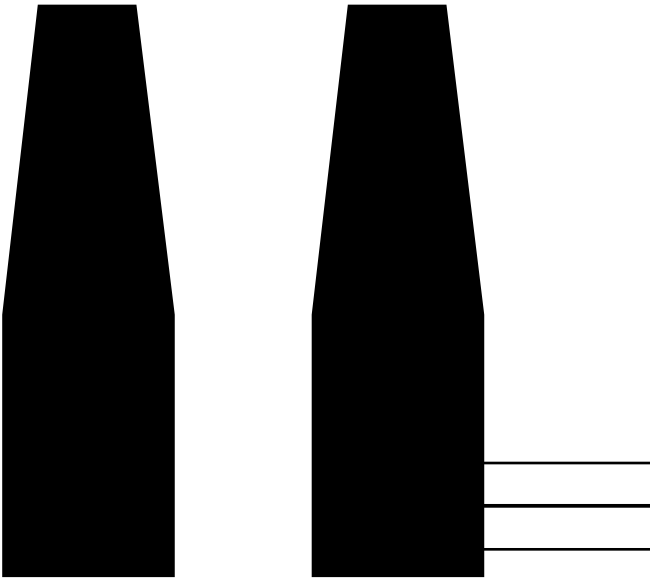

9.4-16 RTO

RTO
3#

4#

+RTO+
3#

4#

30

b

9.4-16 RTO

RTO
3#

4#

+RTO+
3#



9.4-17

		+
	5#	5#
	15	
	800	800
mg/m³	10	10
kg/h	4.9	4.9
mg/m³	5	5
kg/h	0.33	0.33

9.4-17

		+
	5#	5#
	15	
mg/m³	60	60
mg/m³	20	20
mg/m³	/	/
mg/m³	40	40

9.4-17

		+
5#		5#
15		
mg/m³	/	/
mg/m³	/	/
mg/m³	40	40
mg/m³	/	/

9.4-18

6#	7#	+	6#	7#
		30		

/	800	/	800
---	-----	---	-----

mg/m ³	[REDACTED]	/	60
-------------------	------------	---	----

%	[REDACTED]		75.5%
---	------------	--	-------

		1#		+	
		8#	9#	8#	9#
		30			
mg/m³		/	100	/	100
%			19.0%		83.3%

		2#		+	
		10#	11#	10#	11#
		30			
mg/m³		/	100	/	100
%		75.2%		42.9%	





9.4-22

	DA001:RTO	DA002:	DA003:	DA004:1#	DA005:2#	DA006:			(t/a)	(t/a)
							(t/a)	(t/a)		
									VOCs 26.83t/a 13.93t/a 12.90t/a	VOCs 25.24t/a 12.93t/a 12.31t/a
VOCs(t/a)										
(t/a)									21.462	20.847
(t/a)									1.050	1.048
1						300		24h		7200h
2	10%		VOCs							
3	VOCs									

VOCs

VOCs

	V1 kg/h	V2 kg/h	t/a
DA001:RTO			
DA002:			
DA003:			
DA004:1#			
DA005:2#			
DA006:			

10%

VOCs
VOCs

V1 kg/h

V2 kg/h

t/a

9.4-23

mg/m³

1# 2# 3# 4#
1 2 3 4 1 2 3 4 1 2 3 4 1 2 3 4

/
/
/
/
/
/
/
/
/
/

	1#					2#					3#					4#					
	1	2	3	4		1	2	3	4		1	2	3	4		1	2	3	4		
																					0.06

ND

A2230413054102C-1a A2230413054102C-2a

14

9.4-23

mg/m³

1#

2#

9.4.2.2

9.4-25 RTO

	mg/m³
	60

9.4.2.3

“

+RTO+

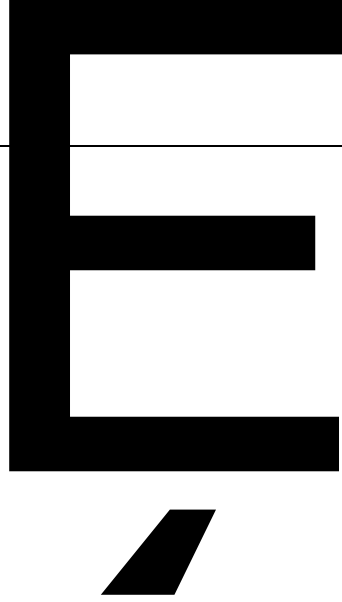

VOCs 25.24t/a

20.847t/a

1.048t/a

9.4.3

9.4.3.1

9.4-26

	2024 1 26			2024 2 3		
3	65	55	65	65	55	65

9.5-2

t

					t		

9.5-3

()

()

□ 8

					()	
					2181.406	/

9.5-4

10.2

10.2-1

10.2-1

10.2-1

10.2-1

11.1

11.2

11.3

11.4

11.1-1

12.1

12.1.1

“ **+RTO+** ”

COD

12.1.2

1

5 #

VOCs 2 0.8 0.48t/a

2

3

4

13.011t/a

0.65t/a

5.204t/a

$1.16 \times 10^{-3}t/a$

3

4

D

12.2

12.3

12.4

